



## 21.5 inch Capacitive Touch Panel PC

( Model:TD215A )

# Product Introduction



Version V1.5

We apologize that if something changed without notice.



## Content

<b>1、Introduction</b>	<b>1</b>
1.1 Brief introduce	1
1.2 Functional Features	1
<b>2、 Technical Parameters</b>	<b>2</b>
2.1 System	2
2.2 LCD Panel	2
2.3 Touch Panel	2
2.4 Electrical Properties	3
2.5 Working Environment	3
2.6 CPU	3
<b>3、Interfaces &amp; Accessories</b>	<b>4</b>
3.1 Touch Screen Monitor	4
3.2 Android Touch PC	4
3.3 Windows Touch PC	4
3.4 Accessories	5
<b>4、 Mechanical Parameters</b>	<b>5</b>
4.1 Physical Specifications	5
4.2 Mechanical Drawing	6
<b>5、 Product Pictures</b>	<b>7</b>
5.1 Overall Pictures	7
5.2 Details	7
5.3 Types	8
5.4 Installations	9
<b>6、 Warning</b>	<b>10</b>



# 1、 Introduction

TouchWo capacitive touch all-in-one computer / monitor integrate the advantages of touch. Computer. Multimedia. Audio. internet, industrial design, structural innovation etc. is a convenient and new type of human-computer interaction equipment. A pure flat structure with excellent touch effects to make the query and display of information at fast speed, and do the human-computer interaction in a simple way .

## 1.1、 Functional Features

1. PCAP Touch : 10 points capacitive touch technology,5ms rapid response, accuracy and stable .
2. Display : Brand new LCD panel with A rated, 1920\*1080 resolution, brightness $\geq 250\text{cd/m}^2$  .colors displayed clear and natural.
3. System : Touch screen monitor and Android touch pc options.
4. Quality Confirmed : Each machine has undergone multiple inspections such as machine aging, temperature and humidity testing, electrostatic testing, vibration, high voltage, touch and click, and display to ensure stable quality.
5. Mechanical : Private module designed, air gap bonding, good seamless design, IP65 at front panel.Pure flat and slim, the thinnest part is 17mm only.
6. Material : Aluminum alloy frame /housing, Unibody ,lighter and good looks,corrosion and oxidation resistance.
7. Customization: customized is welcome. Flexible to add serial and USB numbers.  
(such as colors, logo, camera,LTE module, card reader, fingerprint module and POE power supply etc)
8. Installation: Support wall mount /desktop/embedded installations, plug and play.



## 2、Technical Parameters

2.1、System			
Output (Android PC)	HDMI/VGA output inside		
Input ( Touchscreen monitor )	VGA、 HDMI DVI input		
Touch	PCAP,10 points touch,		
Display	HDMI 1080		
Video decoding	1080P ( Full HD ) MPEG、 H.264 etc		
Design	alloy aluminum frame,metal sheet design, round corner		
System Integration	PC,Display ,touch, button switch		
2.2、 LCD Panel			
Screen Type	A-Si,TFT-LCD, back-light, A-type		
Size	21.5 inch (16:9)		
Display area	477.6 (W) * 269.1 (H) mm		
Resolution	1920*1080		
Brightness	≥ 250 cd/m <sup>2</sup>		
Contrast ratio	≥ 3000: 1		
Response time	13/5(Typ.)(Tr/Td)ms		
Number of colors	16.7M , 74% NTSC LVDS 30 Pins		
Refresh rate	60Hz		
Viewing angle	89/89/89/89 (Typ.) CR≥10) left/right/up/down		
Life time	30000 hours		
2.3、 Touch Panel			
Touch technology	Capacitive touch screen		
Response time	<5ms		
Touch points	10 points standard, zoom in/ zoom out options		
Touch effective recognition	1.5	output method	Coordinate output
Scanning Frequency	200Hz	Scanning accuracy	4096×4096
Communications	USB 2.0,3.0	Theoretical Clicks	50 Millions
Firmware	Upgraded by USB	Driver	NO
Working Current/Voltage	180Ma/DC+5V±5%		
Surface Hardness	Chemically tempered, Mohs class 7 explosion-proof glass		
OS	Win 7/ Win 8/Win 10/CE/Mac/Android/Linux /XP		
2.4、 Power supply parameters			
Input Power	110—240V AC 50/60Hz		
Output power	DC 12V 5A		



Consumption for Touch window	< 60 W		
Consumption for Touch monitor	< 20W		
Consumption for Touch Android	< 36W		
Standby power consumption	< 0.5W	Speaker	4 Ω 3w
<b>2.5、Working environment</b>			
Operating temperature	0℃-50℃		
Working humidity	10% - 80%		
Storage temperature	-5℃-60℃		
Storage humidity	0% - 70%		
Altitude	Under 5000 meters		

## 2.6、CPU

Project	Touchscreen Monitor	Android	x86 elite version	x86 Deluxe Edition	Custom Design
Chip	An external host is required. For detailed parameters, please refer to 3.1	Quad core RK3288 Hexa-core RK3399 Quad core RK3568	Default: Intel J3710/J4125/ J1900	Industrial control board I3/I5/I7	<b>YES</b>
Ram		2gb/4gb	2gb/4gb/8gb/16gb		
Hard Disk		Standard 8G	SSD 32G/64G/128G/256G/512G		
Graphics		16/32G	2.5" HDD: 500G/1T (optional)		
		Android HD	nuclear display		
Definition		720P/1080P			
Operating System		<b>Version number 7.1 (3568, version 11.0)</b>	Win 7/ Win 8/Win 10/ Linux		
NIC		Integrated 10/100 / 1000M adaptive network card, wireless network card 802.11a / b / g / n			



## **3 Interfaces & Accessories**

### **3.1 Interfaces for Touchscreen Monitor**

DC Jack	2.1mm	Audio	1
VGA input(15pin D-Sub)	1	HDMI input	1
USB touch port	1	DVI	1

### **3.2 Interfaces for Android Touch PC**

DC Jack	2.1mm	Headphone	1
RJ45	1	HDMI	1
USB(with OTG)	2	WIFI	1
TF /SD card slot	1	TTL/232/485 options	

### **3.3 Interfaces for windows Touch PC**

DC Jack	2.5mm	RJ45	1
VGA	1	HDMI	1
USB	4	Headphone	1/1
WIFI	1	TTL/232/485 options(2-6)	



## Interface Parameters

### TouchScreen



### Windows



### Android



## 3.4 Accessories

Instructions	*1
AC Power line	*1
Power Adapter	*1
Wall mount/bracket	*1
Warranty Card	*1
Certificate	*1
Cable	HDMI *1; USB*1 (touch monitor only)
WIFI	*1 (standard on PC/Android only)



Instruction



Certificates  
Warranty



Adapter



WIFI



HDMI



USB



Wall Mount  
Brackets



## 4、 Mechanical Parameters

Size	21.5"
Display size	477.6 * 269.1 mm (16: 9)
Machine size (W * H *T)	527 (W) ×325 (H) ×42.6 (T) mm
Package size (W * H *T)	570 (W) ×440 (H) ×145 (T) mm
Mounting bracket	Wall mounted (0.48kg)
VESA hole	100×100 mm
Wall screw specifications	M4
Net weight	6.59KG
G.W (packaging)	8.67KG

Front View

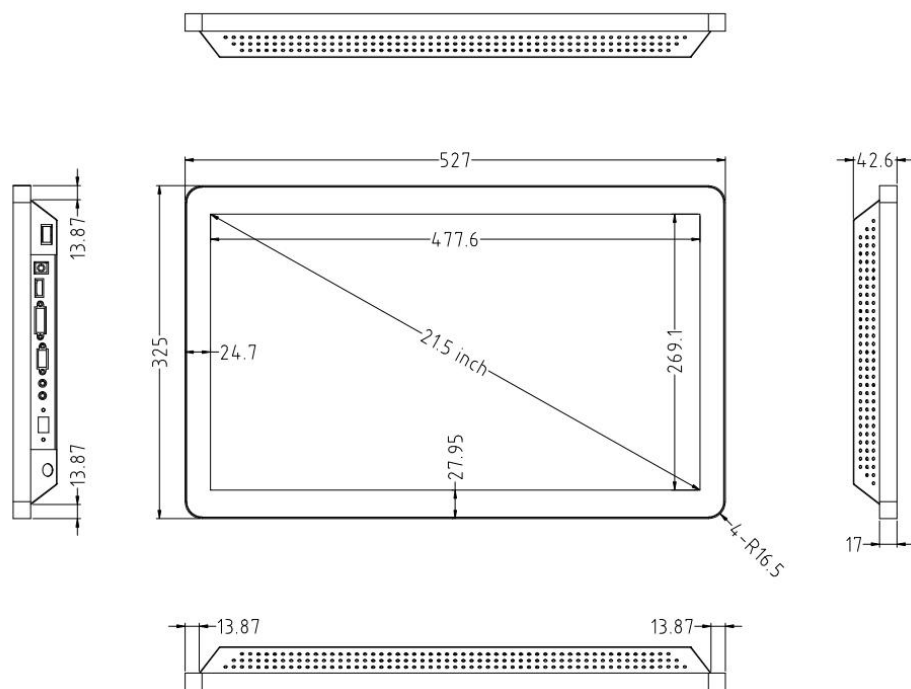





## Back View

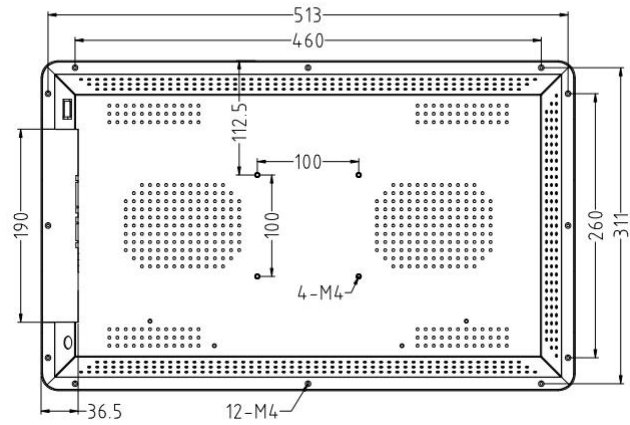

## 5、 Product Pictures

### 5.1 Overall Pictures



## 5.2 Details



## 5.3 Type



Black panel+Silver frame+Black back

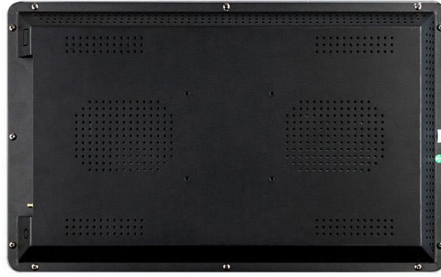

Black panel+ Black frame +Black back

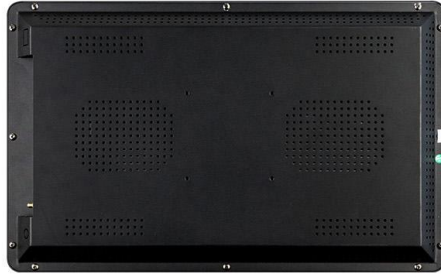

White panel+ Silver frame+White back

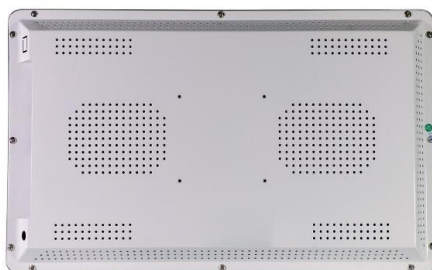

**More colors can be customized**



## 5.4 Installations

Standard with

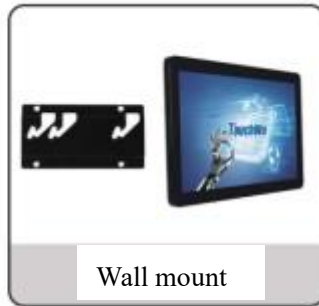

Other styles purchased

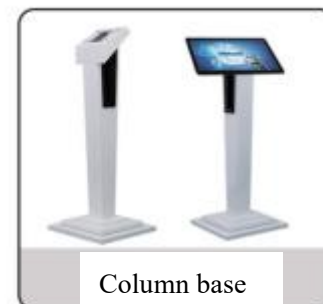



## 6.Warning

1. This product is a precision electronic device, the front is IP65, and the overall protection level is IPX3, so care should be taken to avoid water splashing and rain;
2. Do not place the equipment in a humid environment. Outdoor equipment needs to be equipped with a moisture-proof cover. When it rains and dew condensation, it needs to be protected to prevent water mist from entering the machine and the glass from becoming moldy. Wet use environment will accelerate the rapid aging of electronic components, thereby reducing the service life of this product and causing moisture damage to components;
3. Do not place the device in an environment with strong ultraviolet rays and direct sunlight for a long time. When the temperature is higher than 50°C, ultraviolet rays and high temperature irradiate the screen will accelerate the deflection of liquid crystal molecules, and the screen will accelerate aging. When the outdoor temperature is higher than 50°C, move it indoors or perform shading treatment;
4. The brightness of the product is not less than 250cd/m<sup>2</sup>. In the case of high ambient brightness, the screen display will not be clear. Please avoid placing it outdoors when the sun is strong;
5. When the temperature is lower than 0°C, the screen may not work properly due to the influence of the deflection of the liquid crystal molecules. It is not recommended to use it when the temperature is lower than 0°C;